









Modular ice maker - Sprayer system Daily production up to 155 kg

Hotel	████████████████████
Restaurant	████████████████████
Fast food	████████████████████
Bar	████████████████████
Disco	████████████████████
Fish market	████████████████████
Supermarket	████████████████████
Medical & SPA	████████████████████
Industry	████████████████████

► Position n°



► Features & Plus

- Compact and crystal cube
- AISI 304 SS Scotch Brite finish 
- Tropical class +43°C 
- Removable and cleanable air filter
- Air cooling system
- Easy cleanable internal rounded surfaces 
- RoHS Free 
- Electromechanical operation 
- ON-OFF rocker switch 
- Standard voltage
- HFC Free 



AISI 304 SS
Scotch Brite finish



Removable and
cleanable air filter

► Usable Bins

- Bin 240PE
- Bin 200
- Bin 350

► Available ice cube size

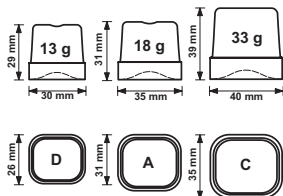

► Prod. 24h

Air temp.	Water temp.		Kg	Lbs	
	7° C	45° F			
	10° C	50° F			155
21° C	70° F	15° C	60° F	152	335

2 Years Warranty
subject to limitations

► Certifications available for this model





Ice Cube

C 150 HC



Modular ice maker - Sprayer system Daily production up to 155 kg

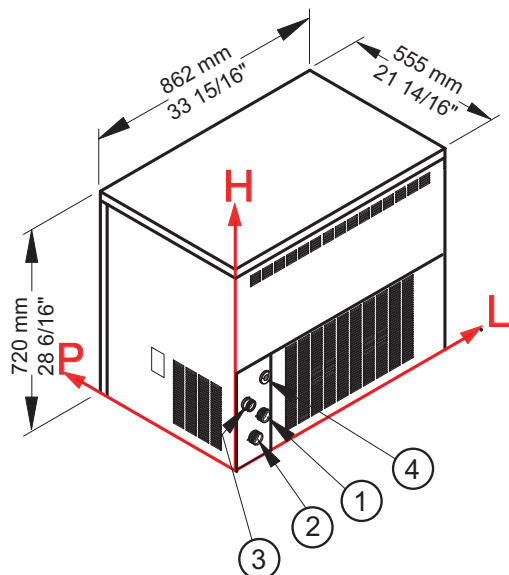

► Working conditions

- Location: **Indoor**

	Min	Max
Ambient temperature	+10° C / +50° F	+43° C / 110° F
Water temperature	+3° C / +37° F	+32° C / +90° F
Voltage	-10%	+10%
Water inlet pressure	1bar (14 psi)	6bar (84 psi)

► Performances

	Air temperature	Water temperature					
		7° C	45° F	15° C	60° F	21° C	70° F
	10° C	155 kg					
	50° F		342 lbs				
	21° C			152 kg			
	70° F				335 lbs		
	32° C					138 kg	
	90° F						304 lbs

► Connections

All measures are referred to the down-left corner (L-H-Ø)

- ① Water in.: 126 mm / 4 15/16" - 284 mm / 11 3/16" - 3/4"
- ② Cond. water in.: 94 mm / 3 11/16" - 234 mm / 9 3/16" - 3/4"
- ③ Water out.: 69 mm / 2 11/16" - 297 mm / 11 11/16" - 24 mm / 15/16"
- ④ Electrical connections: 140 mm / 5 8/16" - 355 mm / 14"

► Technical information

Production in 24h	152 kg / 335 lbs	Water consumption	A: 2 l/kg - 24 gal/100 lbs
Cooling system	A	Sizes (L-P-H mm)	862 - 555 - 720
Kind of cube	A-18g, D-13g, C-33g	(L-P-H in)	33 15/16 - 21 14/16 - 28 6/16
Refrigerant	R290	Sizes with pack (L-P-H mm)	910 - 605 - 955
Standard voltage	220-240 V ~ 50 Hz	(L-P-H in)	35 13/16 - 23 13/16 - 37 10/16
Average power consumption	1260 W	Net weight	118 kg / 260 lbs
Fuse	16 A	Gross weight	128 kg / 282 lbs
Electrical consumption	20 kWh/100kg	Finish	AISI 304 stainless steel, scotch brite

All the technical information need to be considered at the following conditions:

- Standard Cube (18 g)
- Ambient temperature +21° C
- Water temperature +15° C
- Average power consumption at +43° C (standard voltage)

Models and specifications are subject to change without notice

Rev. 01 - Issued September 2019



www.bremaice.it
info@bremaice.it

Bim + Data
download

